



**TDAI-2170
INTEGRATED AMPLIFIER &
AUDIO PROCESSOR**

OWNER'S MANUAL

April 2021

Contents

What's in the box	4
Remote Control	5
Front Panel	6
Rear Panel	7
Speaker setup guide	8
Using the TDAI-2170 in a Surround System	11
Menu walkthrough	12
1 RoomPerfect™	12
2 Voicing	12
3 Speaker setup	12
4 Setup	12
4.1 Inputs	12
4.2 RoomPerfect™ setup	14
4.3 Volume	16
4.4 Voicings	16
4.5 Display	16
4.6 HDMI	17
5 Advanced settings	18
5.1 Auto off	18
5.2 Remote control	18
5.3 ICC	18
5.4 Speaker setup guide	18
5.5 Second speaker setup	18
5.6 Outputs	18
5.7 Trigger mode	21
5.8 Lock setup	21
5.9 Software info	21
5.10 Factory reset	21
FAQ and recommendations	22
RoomPerfect™ troubleshooting	23
Cleaning and maintenance	23
Serial control manual	23
Technical assistance	23

Welcome

Congratulations on your purchase of the Lyngdorf Audio TDAI-2170 fully digital amplifier with Room- Perfect™.

With this purchase, you have joined the ranks of an elite group of people who believe that perfect sound is more than a luxury. It's a requirement. The TDAI-2170 will deliver an audio experience that will far exceed your expectations. We thank you for placing your confidence in Lyngdorf Audio.

This manual will give you an overview of how to set up your system. Please read the manual carefully to better understand the capabilities of your TDAI-2170. For more in-depth information about the technologies used in Lyngdorf Audio products, please visit www.lyngdorf.com.

COMPLIANCE

WEEE

The European Parliament and the Council of the European Union have issued the Waste Electrical and Electronic Equipment Directive. The purpose of the Directive is to prevent waste of electrical and electronic equipment and to promote reuse, recycling, and other forms of waste recovery. Lyngdorf products and the accessories packed with them are subject to the WEEE Directive. Please dispose of any waste materials in accordance with your local recycling regulations. Products and equipment which must be collected for reuse, recycling, and other forms of recovery are marked with the icon of the crossed-out waste receptacle.



FCC

Lyngdorf products and accessories comply with parts 15 and 68 of the FCC rules. Operation is subject to the following two conditions: (1) this device may not cause harmful interference; and (2) this device must accept any interference received, including any interference that may cause undesired operation.

What's in the box

Microphone stand

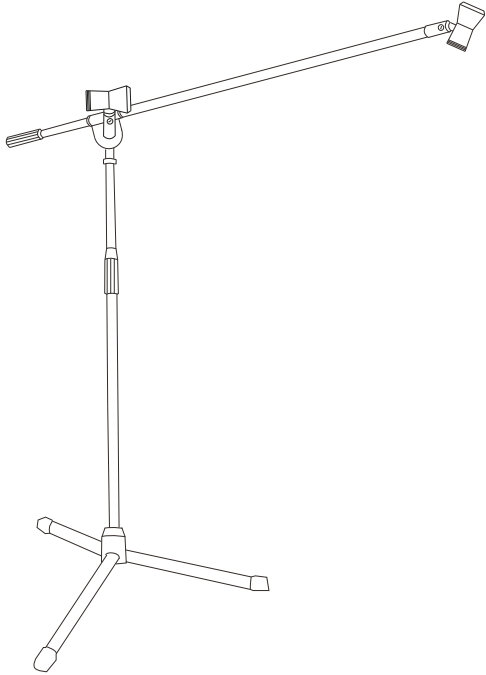

Microphone

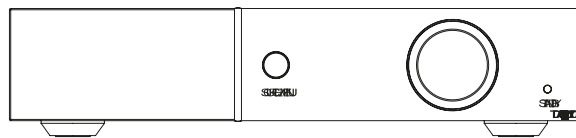
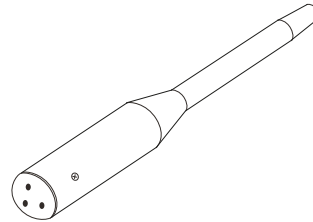

TDAI-2170

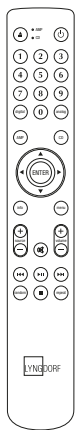

Remote control

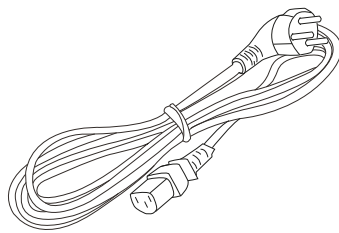

Mains cord

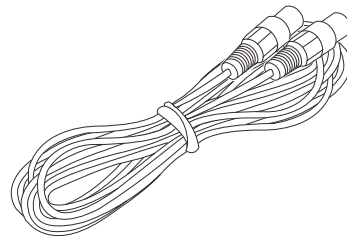

8 m (26 feet) XLR - XLR cable

Remote control

The most frequently used buttons

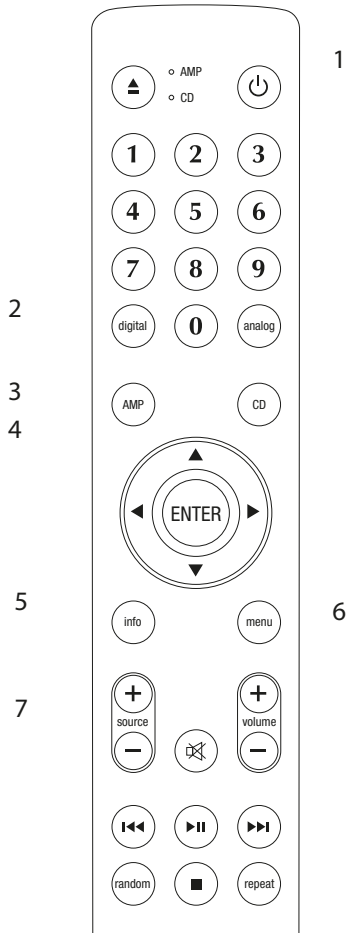

1. Standby Turns the TDAI-2170 on and into standby.

2. Digital and Analog Selects input type - or if already active, cycles to the next input.

3. AMP / CD Changes remote operation between the TDAI and the Lyngdorf CD player.

4. Up/Down Toggles between the available RoomPerfect™ filters and increases or decreases settings in the menu.

5. Left/Right Toggles between neutral and the available voicings and is used to browse in the menu.

6. Enter Choose a menu or setting

7. Info Shows information of level and type of input signal.

8. Menu Press to enter the menu. When in the menu press to go back or cancel.

9. Source +/- Toggles between active inputs.

10. Volume Increase or decrease the volume level

Notes:

The buttons below are for controlling a Lyngdorf CD Player only

If the TDAI-2170 isn't responding to the volume control of the remote, press the AMP key and try again. If that doesn't work, check the two AAA batteries.

Front panel controls



Left to Right:

- 1. Source/menu**
Press and hold to access the menu, press to select a menu item, press and hold to exit a menu. Rotate left and right to toggle between audio sources and browse while in the menu. Press to mute and unmute.
- 2. Volume wheel**
Adjust the volume with left or right rotation.
- 3. Standby button**
Turns the TDAI-2170 on and into standby.

Rear Panel



On the back of the TDAI-2170, you can find a range of inputs and output connectors:

Top Row / Left to Right:

- Optional Module with 1 x phono (MM), 2 x single ended, and 1 x balanced analog audio inputs
- Optional Module with 1 x TV HDMI output (ARC) and 3 HDMI inputs, all 4K /HDR compatible
- Speaker Outputs

Low Row / Left to Right

- 2 x single ended analog audio inputs
- 1 x single ended analog audio output
- 1 x balanced analog microphone input (for RoomPerfect™ calibration)
- 2 x coaxial digital audio inputs
- 4 x optical digital audio inputs
- 1 x coaxial digital audio output
- 1 x USB A connector for software updating (FAT32 Format required)
- 1 x RJ12 connector for serial control of the unit
- 1 x trigger input and 1 x trigger output
- 1 x Mains voltage connector

HOW TO GET STARTED / Speaker setup guide

Set up the TDAI-2170 integrated amplifier by following these steps:

1. Connect the speakers and subwoofer(s) to the Speaker Output connectors – see below.
2. Connect all external equipment, audio and video, mains power, etc. to the TDAI-2170.
3. Connect the TDAI-2170 to the mains power and turn on the mains switch.
4. Switch on the TDAI-2170 using the front stand-by button.

When the TDAI-2170 is turned on for the first time, the Speaker Setup Guide will start. This guide will ensure that you pass through the full setup process, but you can always back out of this guide by a long press on the Source/Menu button.

Settings can be modified later under the Output Menu – or you can activate the Speaker Setup Guide to start all over.

When connecting the speakers, always connect + and - from the amplifier to the corresponding + and - terminals on the speaker.

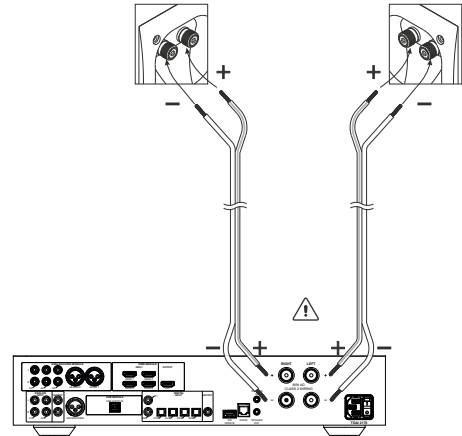

Warning:

Never run the TDAI-2170 in bridged mode with other amplifiers – nor should you ever connect speaker cables to 'High Level' inputs on a subwoofer. Connecting the speaker output terminals of two amplifiers will, because of the way a fully digital amplifier works, seriously damage the amplifier.

Tips for setting up speakers

You can use the stereo triangle as a good rule of thumb when determining where to place your speakers. The distance between the speakers should be the same as the distance from your listening position to both speakers.

If your room does not accommodate the optimal listening setup, the TDAI-2170 can compensate for this, when you enter the actual distances to each speaker through the Speaker Setup Guide.

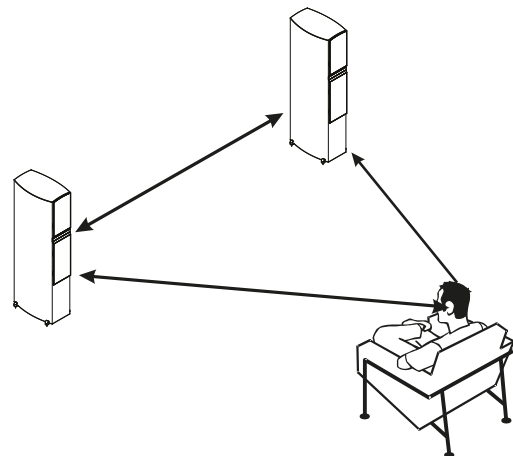

Reflections and Echoes

The direct sound from the speakers is strongly affected by the dimensions of the room and the surfaces of the walls, floor and ceiling. RoomPerfect™ will compensate for the negative effects experienced, but the reflections or echoes will still reduce the perceived performance of the audio system.

You can reduce reflections from the hard floors and hard surface walls by positioning a carpet, painting, a bookshelf, or other furnishings between you and the speakers and/or behind you. Find the position of the diffusers by having someone hold a mirror flat against the wall or floor. When you can see the speaker in the mirror from the listening position, you have found the optimal position for the diffuser.

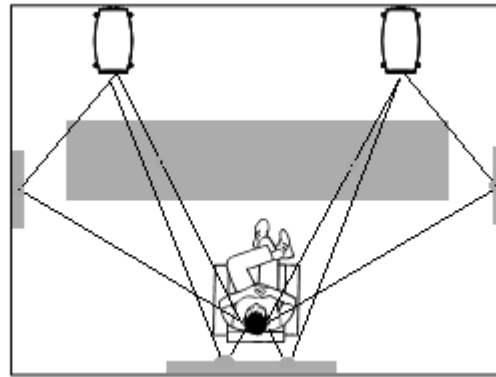

Note:

Reducing reflections can also be achieved by spreading the direct reflection – these are known as diffusers. We do not recommend extreme dampening of the room reflections – like in a public cinema. RoomPerfect™ works optimally in a room with comfortable acoustics.

Speaker placement with RoomPerfect™

Traditionally speakers must be positioned in the room with different distances to back and side walls, so that sound reflecting from the walls does not reach your ear at the same time. This is to optimize the frequency response, but at the cost of timing, as the reflections are causing a beat to be smeared out over a longer time.

With a RoomPerfect™ calibration you can optimize the timing by placing your speakers against the back wall, opposite from your preferred listening position. This will ensure the largest sound reflection from the back-wall and the direct sound will reach your ears at the same time, giving you better timing. The damage to the frequency response will be cleaned by RoomPerfect™

If your speakers have a bass-reflex port on the back, you should allow for a 5cm/2in clearance to the back wall. This will ensure there is no disruption to the functionality of the port.

Connecting a subwoofer

The TDAI-2170 features a crossover function for optimal integration with a subwoofer.

When connecting to a Lyngdorf BW type subwoofer, you connect the analog output of the TDAI-2170 to the BYPASS input of the subwoofer.

In a traditional single subwoofer setup, connect the subwoofer to the left analog output on the TDAI-2170. For a stereo subwoofer setup, or if you have a subwoofer which has stereo input, use both left and right analog outputs.

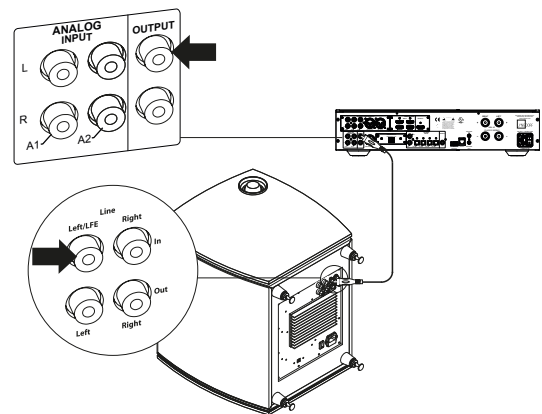

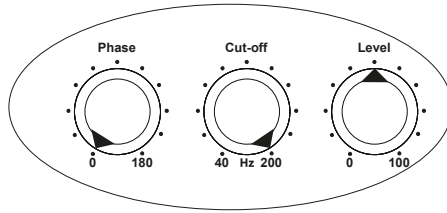
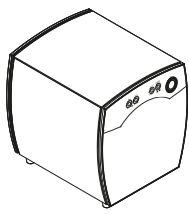

Subwoofer controls

1. Phase adjustment should be 0°.
2. The subwoofer cut-off frequency should be set to the highest possible frequency range.
3. Level should be set to 50% of maximum volume.

Warning:

Do not connect the TDAI-2170 to a subwoofer with High Level / speaker terminal inputs, as this will seriously damage the amplifier.

Subwoofer placement

With a single subwoofer, we recommend placing the subwoofer against the wall between the main speakers.

With two subwoofers, you should position one in each front corner, in line with the main speakers.

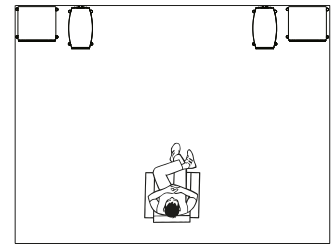
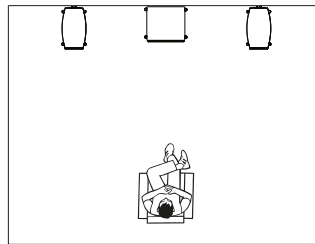

Measuring distances

When measuring the distance to your main speakers, measure from the preferred listening position (the focus position) to the front of the speakers.

When measuring the distance to a subwoofer, measure from the preferred listening position to the back corner of the subwoofer.

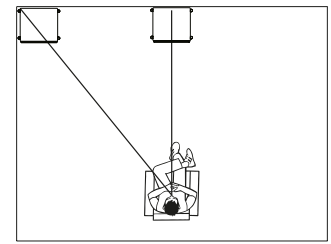
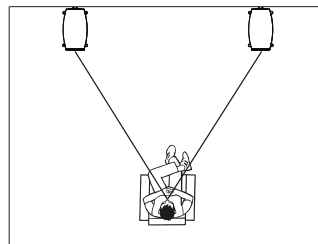

Using the TDAI-2170 in a Surround System

Integrating a TDAI-2170 with RoomPerfect™ into your surround sound setup enables you to make the most of your system's front speakers and subwoofer(s) and enjoy the full benefits of RoomPerfect™. The process is easier than you might expect.

Important note: make sure your surround sound receiver has a front speaker "pre-out" connector.

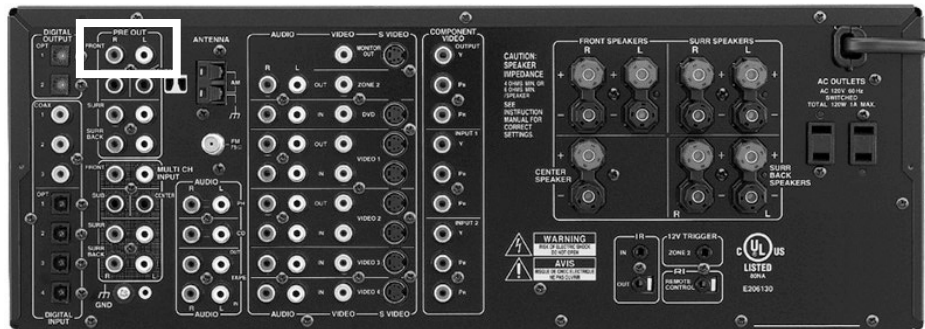

Setup of surround receiver

On the surround receiver, adjust the settings as follows:

1. No subwoofer connected; this must be connected to the TDAI-2170 instead.
2. Front speakers: X-Large, or corresponding reference for full frequency range speakers.
3. Measure and set up the distances/delays to the front speakers.
 - Measure the distance to your front left and right speaker, and the subwoofer if you have one in your setup.
 - Take the longest distance measured and add 52 cm / 20.5 in. This adjusts for the delay caused by the processing of the TDAI-2170.
 - Input this number for BOTH the left and right speaker in the surround receiver menu.
4. Connect the surround processor's front speaker "pre-out" to a stereo analog input on the TDAI-2170.

Setup of the TDAI-2170 in a surround sound system

For the TDAI-2170, adjust the settings as follows:

1. Set up two front speakers, and subwoofer(s) as described in "Speaker setup guide" on page 6.
2. Measure and input the correct distances to the speakers and subwoofer.
3. Perform a RoomPerfect™ calibration of the stereo system.
4. In the surround processor, adjust the levels to uniform between the surround, center, and stereo system.

Hot Tips

You can set the TDAI-2170 to dedicate a specific Voicing when you select the input connected to the surround receiver; see how in "4.1.4 Default voicing".

Turn the TDAI-2170 into a dedicated power amplifier when used in a surround sound setup.

Select the input connected to the surround processor and enter the menu system: 1. Go to 'Setup' / 'Inputs' / 'Home Theater' / Choose 'Enable'.

Warning: Do not test this setting with a CD player or similar unregulated signal!

Menu walkthrough

1 RoomPerfect™

Selects between the available focus and global RoomPerfect™ filters.

RoomPerfect™ is designed to analyse and correct for the negative effects that the listening room has on the speaker sound. The focus filters improve the sound quality at a specific listening position, called a “focus position.” This makes the focus filter the best solution for optimal sound quality at a single listening position.

The global filter improves sound quality across the whole room. When you are moving around a room, the global filter gives the best result.

2 Voicing

Toggles between the available voicings, which adjusts the sound to your liking.

A voicing is an equalizer filter that can be activated to amplify or attenuate certain frequencies according to your personal preferences. This equalization is an addition to the RoomPerfect™ corrections. The equalizer settings of a given voicing can be seen on the display of the amplifier.

Hot Tip:

You can set the TDAI-2170 to dedicate a specific voicing when you select the input connected to the surround receiver; see how in “4.1.4 Default voicing” on page 13.

3 Speaker setup

Select to toggle between speaker setup 1 and 2. *Note: Only active if enabled in Advanced Setting -> 2nd speaker setup.*

4 Setup

4.1 Inputs

In general, the settings in these sub-menus are specifically for the current active input.

Note: We recommend setting the output of a CD-player to 44.1 kHz. The TDAI-2170 will then get the original signal from the disc, which allows for ICC (Intersample Clipping Correction) to function.

4.1.1 Active inputs

Enables and disables individual inputs so you do not have to scroll through unused inputs.

Note: To store the changes made, scroll to the right in the menu and press the “Enter” button when you see “Enter to continue” text.

4.1.2 Input name

Changes the name of the selected input.

Note: To remove all text after the blinking marker, press and hold the “Down” button on the remote.

4.1.3 Sensitivity

Enables you to match input levels from different sources. Can be adjusted up to +24dB.

4.1.4 Default voicing

Selects a default voicing for the input which is active when in this menu. If you always want extra bass on your gaming console audio, for example, set that voicing here.

4.1.5 Home Theater

Turns the amplifier into a dedicated power amplifier for the input which is active when in this menu. This feature bypasses the volume control. **Warning: Do not test this setting with a CD player or similar unregulated signal!**

This feature might be selected if you are using the TDAI-2170 in a home theater setup where it is used to power and calibrate the front speakers and/or subwoofer. Connect your home theater processor to the selected input.

When selecting other inputs, the amplifier returns to the last current volume.

4.1.6 Lipsync delay

If the connection of a display has introduced asynchronous playback of audio and video, you can select a delay time in to ensure that the video and audio signals are played back simultaneously.

4.2 RoomPerfect™ setup

4.2.1 RoomPerfect™ guide

This will start the guided RoomPerfect™ setup and will erase previously stored calibrations. When completed, the other menus are available in the RoomPerfect™ setup menu.

Placing the microphone in the focus position

When you are prompted to place the microphone in the focus position, connect the microphone to the microphone input **on** the back panel using the provided microphone cable and place the microphone, using the microphone stand, in your primary listening position. The height and the orientation of the microphone should correspond to your head's height and direction.

Press enter and a test signal will start from the left speaker. The TDAI-2170 will give an estimated optimal volume for calibrating the system or will accept the current volume. Adjust the volume if required and retry the measurement.

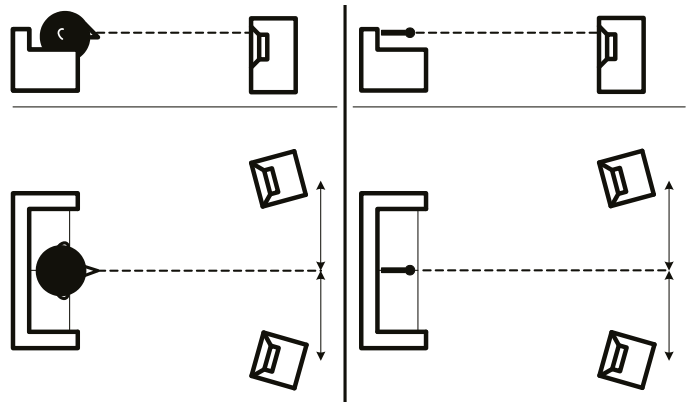

The calibration volume should not be so loud that it is inconvenient to you, or that it causes damage to your loudspeakers. If this is the case, set it to a lower and more appropriate level. A low volume can result in a longer calibration time (in excess of two minutes) or a measurement time out. A low volume and long measurement will not affect the quality of the result.

Measuring the focus position

When the calibration volume has been set, RoomPerfect™ will send a range of tones to measure the focus position. If there is noise in the room, the measurement may take longer. This will not affect the quality of the result.

See “RoomPerfect troubleshooting” on page 18 if you experience problems.

Measuring random room positions

When the focus position has been measured, the next step is to measure the acoustical properties of the room. It is important to perform well spaced measurements to get a comprehensive image of the acoustical properties of the room. See “RoomPerfect troubleshooting” on page 18 if the measurement stops prematurely.

Keep taking measurements until Room Knowledge reaches 90%, when the system has enough information to do a calibration.

These are the rules of thumb when measuring the room:

- the microphone must always have a clear line of sight to the tweeter mid-range of the speaker.
- the microphone should be in random and varying positions, heights, and orientations. Point it up/down/sideways, the more random positions the better.
- the measurements should cover the entire room, not only your listening area.
- the microphone should not be closer than 0.5m/1.5ft from the floor, ceiling and walls.
- the microphone should be at least 1m/3ft from the front of the loudspeakers.
- there should be at least 50cm/1.5ft between each measurement.
- do NOT take symmetrical measurements in the room.

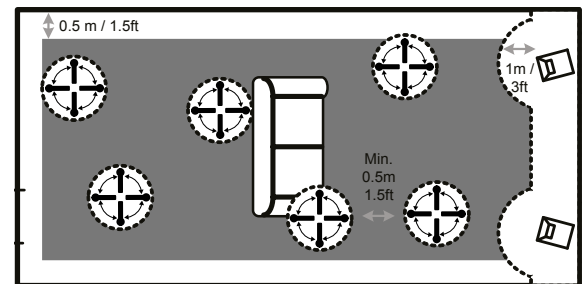
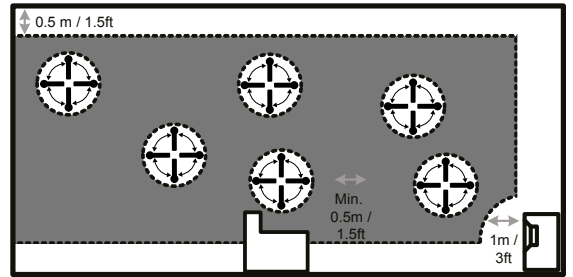

Room measurements above 90% Room Knowledge

Note that Room Knowledge is calculated by the computer as how much from the new measurement it already knows. If the Room Knowledge index does not increase after a measurement, you have added a good measurement with a lot of new information.

To fully optimize RoomPerfect™'s understanding of the room's acoustical properties, we recommend you keep doing measurements until the Room Knowledge is above 95%. The higher the Room Knowledge, the more accurate the room correction filters will be.

4.2.2 Status

This screen shows how many room measurements have been made, together with the RoomKnowledge and RoomCorrection index.

The Room Knowledge index is an estimate of how much of the room's acoustical properties have been learned from the room measurements. The higher the Room Knowledge index, the greater the accuracy of the calibration.

The Room Correction index is an estimate of how much the calibration filter will affect the sound reproduction by evaluating the size of the filters as well as the frequencies adjusted. This index is not absolute. For best results, rely on your own experience of the effects of the filter.

A low Room Correction filter on the focus position could indicate that you have positioned your speakers in order to optimize the frequency response and not the timing.

Check "Tips for setting up speakers" on page 6 and complete a new RoomPerfect™ calibration.

4.2.3 Add focus position

If you would like to add an additional focus position, the chair next to the couch perhaps, it can be done here. It is possible to have up to 8 different focus positions.

The saved calibration volume from the RoomPerfect™ guided setup is used as a default when adding extra focus positions. The volume can be changed at any time between measurements to suit a particular situation. This will not affect the quality of the measurement or the end result.

Add room measurement

It is possible to add more room measurements, which can increase RoomKnowledge and thereby fine tune all the room correction filters.

Status

This screen shows how many room measurements have been made, together with the Room Knowledge and Room Correction index.

The Room Knowledge index is an estimate of how much of the room's acoustical properties have been learned from the room measurements. The higher the Room Knowledge index, the greater the accuracy of the calibration.

Hot Tip: The objective is to have the Room Knowledge index to increase as slowly as possible. This indicates that each measurement holds new data for the calibration. When the measurement does not give new data, the index will increase quickly.

The Room Correction index is an estimate of how much the calibration filter will affect the sound reproduction by evaluating the size of the filters as well as the frequencies adjusted. This index is not absolute. For best results, rely on your own experience of the effects of the filter.

A low Room Correction filter on the focus position could indicate that you have positioned your speakers in order to optimize the frequency response and not the timing.

Check "Tips for setting up speakers" on page 6 and complete a new RoomPerfect™ calibration.

Add focus position

If you would like to add an additional focus position, the chair next to the couch perhaps, it can be done here. It is possible to have up to 8 different focus positions.

The saved calibration volume from the RoomPerfect™ guided setup is used as a default when adding extra focus positions. The volume can be changed at any time between measurements to suit a particular situation. This will not affect the quality of the measurement or the end result.

Add room measurement

It is possible to add more room measurements, which can increase Room Knowledge and thereby fine tune all the room correction filters.

4.3 Volume

4.3.1. Default volume

The default volume setting controls the default volume at start-up.

Maximum volume

The maximum volume setting is a safety precaution used for limiting the maximum volume which can be achieved by spinning the wheel or increasing volume via the remote. This can be set to protect your loudspeakers against overload.

4.4 Voicings

Enables and disables voicings to enable quicker selection of your preferred equalization.

4.5 Display

4.5.1 Display brightness

Display brightness is used to control the brightness of the display.

4.5.2 Display timeout

If enabled, the main display will switch off after 10 seconds of inactivity.

4.6 HDMI

Note: As default, CEC is not active on HDMI to comply with regulations requiring a very low standby power. Turning it on will raise standby power to 1.2W.

NOTE:

Consumer Electronics Control (CEC) is an HDMI feature designed to allow you to command and control CEC-enabled devices that are connected through HDMI, by using only one of their remote controls (for example, controlling the TDAI-2170 audio by using the remote control of the TV).

The level of CEC implementation depends on the manufacturer of each product, and even if brand new, not all electronic devices, including TV or other sources, support CEC.

4.6.1 CEC enable

Enables and disables CEC (Consumer Electronics Control) over HDMI.

4.6.2 CEC power control

Note: Menu only appears if CEC is enabled.

Enables and disables CEC power handling.

This means when you turn on your TV or Blu-Ray player, the TDAI-2170 will automatically switch on from standby as well. Furthermore, if you switch the HDMI input to a product which is in standby, it will be turned on.

4.6.3 CEC audio system

Enables and disables CEC audio system.

When enabled the TDAI-2170 tells the TV to disable its built-in speaker and to use the ones connected to the TDAI-2170. Furthermore, this enables you to control the TDAI-2170 volume with the TV's remote

4.6.4 TV input

Select "HDMI ARC" if your TV supports ARC (Audio Return Channel) over its HDMI connection.

This means your TV can stream audio back through its HDMI connection to the TDAI-2170.

If your TV doesn't support ARC, you can connect an analog or digital audio output from the TV to an audio input on TDAI-2170. Select the used input in this menu so the TDAI-2170 will know from which input the audio from the TV is coming. Remember to set up the TV to output to PCM on the digital output.

Note: If you don't get any sound when the TV is connected to an alternative audio input, you may need to turn off your TV and turn it back on again.

4.6.5 Output enable

Enables and disables HDMI audio output to the TV. This feature is only available if the digital output connector is not in use.

When enabled, this feature will send the current digital audio signal through the HDMI cable to the TV. Disable if you want the TDAI-2170 to send the current audio signal to the digital output connector on the back.

5 Advanced settings

5.1 Auto off

If you don't press any buttons or audio isn't being played, this sets the idle time required for automatic shut-down of the amplifier.

5.2 Remote control

Activate or deactivate the remote control. This function is useful if you are using a home automation system and other remotes are using the same IR codes as the TDAI-2170 remote.

A home automation system is connected to the TDAI-2170 through the RS232 connector. Codes are available for download from www.lyngdorf.com

5.3 ICC

Audio signals that exceed 0 dBFS (decibels relative to full scale) will be clipped when processed in the audio chain and will result in more or less distortion. With ICC (Intersample Clipping Correction) the TDAI-2170 will dynamically allow for extra headroom to avoid clipping.

ICC (Intersample Clipping Correction) can be set to auto or disabled.

The TDAI-2170 will continuously adjust the ICC in order to avoid clipping. Changing inputs or going into standby mode will reset the ICC.

If you switch to an active audio input and press info on the remote, you will see a "peak level" measurement. This will show you if your signal has exceeded 0 dBFS. "

5.4 Speaker setup guide

This starts the guided speaker setup and RoomPerfect™ setup. See "RoomPerfect" on page 10 for instructions in how to calibrate your system.

Warning: This will erase all previously stored speaker settings and RoomPerfect™ measurements.

5.5 Second Speaker Setup

Here you have the option to store a second speaker setup. This will allow you to test another setup or to have calibrated setups with and without a subwoofer, etc.

Enabling this will start the Guided Speaker Setup. When complete, the menu item Speaker Setup will be available in the main menu, allowing you to switch between the two setups.

5.6 Outputs

The menus in outputs are where you will manually set up delays and crossover filters for your speaker system. If the guided speaker setup has been completed the pre-made settings will be shown; these can be optimized as well.

When building active speaker systems, it is recommended that you use the original crossover point(s) used by the manufacturer. Due to the short wavelengths of the mid/high frequencies, it is essential that crossover frequency, filter type, order, and delay are set correctly. Therefore, creating filters for speakers is an iterative process that requires great knowledge and several critical listening sessions in order to achieve seamless integration of the different speaker drivers.

Note: If you change the output setting, you have to do a new RoomPerfect™ calibration.

5.6.1 Delays

The available settings are:

Distance

If you are using a setup with speakers and/or subwoofers located at an identical distance to the listening position, you don't need to set a distance. If the distances are not identical, you need to enter it in order to ensure that the sound from each loudspeaker reaches the listening position simultaneously.

To correctly measure the distance, please see Guided Speaker Setup.

Amplifier delay

On analog and digital out, you can set an amplifier delay. If you have an active subwoofer or an additional amplifier, there will be a natural electronic delay in these products.

Refer to the original manufacturer's instructions to obtain the correct amplifier delay.

5.6.2 Main speaker output

The available settings are:

High pass removes the frequencies below the crossover frequency.

Low pass removes the frequencies above the crossover frequency.

Full range allows the signal to pass unfiltered.

Off mutes the output.

5.6.3 Analog output

The available settings are:

High pass removes the frequencies below the crossover frequency.

Low pass removes the frequencies above the crossover frequency.

Full range allows the signal to pass unfiltered.

Headphone disables RoomPerfect™, voicings are still available. Muting the TDAI-2170 will only mute the speakers, not this output.

Tape Out disables RoomPerfect™, voicings and volume control.

Off mutes the output.

Volume

The volume can be set to regulated or full scale. Regulated means that the output level will follow the level of the volume control. Full scale means there is a constant full scale output.

Warning: If full scale is selected, you will have full volume output, and this can overload and damage speakers.

Output level

This adjusts the overall output level in order to align the level of a subwoofer to the level of your main speakers. Making the output adjustment here is far better than attenuating the level on the subwoofer itself.

L/R signals

Choose whether you want the output to be a stereo or mono signal. Choose mono if you use a single subwoofer with mono analog input; choose stereo if you have two subwoofers or one with a stereo input. See "Connecting the subwoofer" chapter.

5.6.4 Digital output

The available settings are:

High pass removes the frequencies below the crossover frequency.

Low pass removes the frequencies above the crossover frequency.

Full range allows the signal to pass unfiltered.

Headphone disables RoomPerfect™, voicings are still available. Muting the TDAI-2170 will only mute the speakers, not this output.

Tape Out disables RoomPerfect™, voicings and volume control.

Volume

The volume can be set to regulated or full scale. Regulated means that the output level will follow the level of the volume control. **Warning:** If full scale is selected, you will have full output to your speakers, which can overload and damage them.

Output level

This adjusts the overall output level in order to align the level of a subwoofer to the level of your main speakers. Making the output adjustment here is far better than attenuating the level on the subwoofer itself.

L/R signals

Choose whether you want the output to be a stereo or mono signal. Choose mono if you use a single subwoofer with mono digital input; choose stereo if you have two subwoofers or one with a stereo input.

5.6.5 Low pass filter

If a filter is selected, the frequencies below the selected crossover frequency will be directed through the designated output terminals.

The available settings are:

Type

LR: (Linkwitz Riley) 2nd, 4th or 8th order.

BW: (Butterworth) 1st, 2nd or 4th order.

In setups using conventional active subwoofers, we recommend using a 2nd order Butterworth filter.

In active speaker systems, we recommend starting with a 4th order Linkwitz Riley filter.

In a configuration with Lyngdorf Audio BW-1 speakers, we recommend using a 4th order Linkwitz Riley filter.

5.6.6 High pass filter

If a filter is selected, the frequencies above the selected crossover frequency will be directed through the designated output terminals.

The available settings are:

Type

LR: (Linkwitz Riley) 2nd, 4th or 8th order.

BW: (Butterworth) 1st, 2nd or 4th order.

Choose a filter type that matches the one you have selected for the low pass filter.

Frequency

The crossover frequency can be selected anywhere between 20 – 9999Hz.

5.7 Subsonic Filter

Enables and disables a filter to remove all sound below 18 Hz.

5.8 Trigger Mode

The trigger input can be used to activate the TDAI-2170 from a source. The available settings are Amp. Power Mode or a specific input.

Amp. Power Mode will start the TDAI-2170 on the input last used.

If you want the TDAI-2170 to start on a specific input when triggered, choose it here.

Note: If the TDAI-2170 has been switched to another input, the trigger command from the source connected will not turn off the amplifier.

5.9 Lock setup

Lock the menu system to avoid unintentional changes.

Unlock the menu system by entering the code 7800. When the code has been entered, and you exit the setup menus, the menu lock will reactivate automatically after 5 minutes.

5.10 Software info

Lists the software versions the TDAI-2170 is using. Refer to www.lyngdorf.com for the latest software.

To update the TDAI-2170:

Save the new software on a FAT formatted USB drive.

Insert the USB drive into the "SW Update" connector on the back of the TDAI-2170.

Turn off the TDAI-2170 at the main switch on the back.

Hold down the standby button on the front and turn on the main switch on the back.

When the display says UPDATING, release the standby button and the TDAI-2170 will update the software. When the update is finished, the amplifier goes into standby.

5.10 Factory reset

Restores the system to the default factory settings.

Warning: All user preference settings, system data, and RoomPerfect™ data are lost when restoring to default settings!

Connecting a PC to the USB B input / streaming audio driver

To stream audio from a Windows PC to the TDAI-2170, you need to install a dedicated Windows drivers (includes ASIO driver) on your pc, which will ensure correct operation and optimal performance. The driver can be found on www.lyngdorf.com. Mac and Linux users do not need to install any drivers to stream audio to the TDAI-2170.

Using the USB streaming audio input

To stream music to the TDAI-2170, connect it to your computer via a USB cable.

Select "USB" as input on the TDAI-2170 and start playing music on your computer.

FAQ and recommendations

When do I need to do a new RoomPerfect™ calibration?

If you change the position of speakers, the crossover settings or if you change your furniture position or type, you need to do a new calibration, as these changes have an impact on the room acoustics.

What should I set my CD-players sample rate output to?

44.1 kHz. This will allow the ICC feature of the TDAI-2170 to avoid clipping of the signal.

What does the Info button on the remote do?

If you switch to an active audio input and press Info on the remote, you will see the following:

Peak Level

This will show you the peak signal relative to 0 dBFS (decibels relative to full scale) and is used for manually setting up the Input Gain or ICC (Intersample Clipping Correction). If the peak level shows +3.4, you should set the ICC to -3.4.

When you switch to a new input or go into standby mode, all measurements, including Peak Level, are reset. If you stay on an input, the Peak Level data is stored, and the maximum value is shown.

Note: We recommend that you set the ICC function to AUTO, which will activate if a signal is too high.

Sample frequency

Sample frequency of the input signal.

Bit resolution

Resolution of the digital input signal.

Audio format

Can show the following: No signal / PCM / DSD / Unknown

If Unknown is shown, the TDAI-2170 cannot read the type of signal and you will not hear anything from your speakers.

My remote control does not work properly

Press the "AMP" button to enable the remote control to operate the TDAI-2170 amplifier.

The multifunction remote control can operate several Lyngdorf Audio products.

Check the batteries.

RoomPerfect™ troubleshooting

The calibration microphone is very sensitive and may pick up unwanted noise, including subsonic signals and background noise, which disturbs the measurements. If the signal is disturbed it will take longer for the system to make a correct measurement.

A measurement that has been disturbed by noise but completed will always be correct; it is not necessary to redo it. If the measurement has stopped due to an error, one of the following error messages will be shown.

Signal error! Check microphone and cable, then press enter

No microphone is connected, or the microphone cable is not working. Check that the microphone cable is connected to the microphone socket on the back panel. If the problem continues, test the microphone cable by connecting the microphone directly to the microphone socket and select Retry.

If the microphone is detected, replace the microphone cable and retry the measurement.

Error: Signal clipping - or - Error: Too much noise

Either the incoming signal has been classified as too loud, resulting in clipping or distortion, or a loud noise in the immediate environment has corrupted the measurement results. If a loud noise has in fact occurred, such as the sound of a closing door, reduce noise levels inside and in the immediate vicinity of the room and repeat the measurement. If no loud noise has occurred, reduce the volume of the signal and repeat the measurement.

Error: Signal too low.

This error message is displayed when the measurement has lasted more than 5 minutes for the low-frequency signal or more than 2 minutes for the high-frequency signal. This happens most often when using a low-level measuring signal compared to the background noise in the listening environment, which results in prolonged measuring times. Raise the measuring signal volume or reduce the noise in the environment before continuing with the measurement.

Cleaning and maintenance

The TDAI-2170 does not require any regular maintenance except to keep its exterior clean. Simply wipe it with a clean, soft cloth. A small amount of non-abrasive cleaner may be used on the cloth to remove any dirt or fingerprints. Do not use abrasive cleaners or cleaners containing liquid solvents.

Serial Control Manual

To get a copy of the Serial Control Manual, which describes how the serial control interface of the device works, download it from www.lyngdorf.com, or contact your local Lyngdorf Audio representative.

Writing software for controlling requires special knowledge. Lyngdorf Audio will not support in writing any serial control software.

Technical assistance

For the latest version of this manual, please check the Lyngdorf Audio website: www.lyngdorf.com.

If you have any problems with or questions regarding your Lyngdorf Audio product, please contact your nearest Lyngdorf Audio representative or:

SL Audio A/S

Ulvevej 28, 7800 Skive, Denmark

E-mail: contact@lyngdorf.com

Web: www.lyngdorf.com

